

JinkoSolar Photovoltaic Modules

Installation and Instruction Manual



TYPE	MODULE
MONOFACIAL	JKMxxxN-48HL4M-DV
	JKMxxxN-48HL4M-DB
	JKMxxxN-54HL4R-(V)
	JKMxxxN-54HL4-(V)
	JKMxxxN-54HL4R-B
	JKMxxxN-60HL4-(V)
	JKMxxxN-72HL4-(V)
	JKMxxxN-66HL4M-(V)
BIFACIAL	JKMxxxN-48HL4M-BDV
	JKMxxxN-54HL4M-BDV
	JKMxxxN-54HL4R-BDB
	JKMxxxN-72HL4-BDV
	JKMxxxN-72HL4-BDX
	JKMxxxN-78HL4-BDV
	JKMxxxN-66HL4M-BDV
	JKMxxxN-66HL4M-BDX
	JKMxxxN-66HL5-BDV

Abbreviations

A: *Amper. Unit of current.*

AC: *Alternating Current.*

AR: *Anti Reflection.*

BIPV: *Built Integrated Photovoltaic.*

DC: *Direct Current.*

e.g.: *exempli gratia (for example).*

EPC: *Engineering, Procurement, and Construction.*

EVA: *Ethylene Vinyl Acetate.*

i.e.: *id est (that is).*

IEC: *International Electrotechnical Commission.*

IP: *Ingress Protection.*

Isc: *Short circuit current.*

mm: *Millimeter. Unit of length.*

m: *Meter. Unit of length.*

N: *Newtons. Unit of force.*

Nm: *Newton meter. Unit of torque (moment).*

Pa: *Pascal. Unit of pressure.*

pcs.: *pieces. Number of items.*

POE: *Polyolefin Elastomer.*

PPE: *Personal Protective Equipment.*

PV: *Photovoltaic.*

RH: *Relative Humidity.*

STC: *Standard Test Conditions.*

TBP: *Tributyl Phosphate.*

TC_{voc}: *Temperature coefficient of open circuit voltage.*

UV: *Ultraviolet.*

Voc: *Open circuit voltage.*

W: *Watt.*

Table of Contents

1. Introduction	1
1.1 Rules and regulations	1
1.2 Disclaimer	1
2. General information	3
2.1 Regular safety	5
2.2 Electrical performance safety	8
2.3 Operation safety	9
2.4 Fire safety	10
3. Installation conditions	11
3.1 Climate/Environment conditions and Site selection	11
3.2 Tilt angle selection	12
4. Mechanical Installation	12
4.1 Fixed installation-mounting with bolts	13
4.2 Fixed installation-mounting with clamps	15
4.3 Tracker Installation	20
5. Electrical Installation	21
5.1 Electrical property	21
5.2 Wiring and cables	23
5.3 Grounding	25
6. Maintenance and care	26
6.1 Visual inspection	26
6.2 Cleaning	27
6.3 Inspection of Connectors and cables	27

1. Introduction

Thanks for choosing JinkoSolar photovoltaic (PV) modules (hereafter referred to as “Modules”). This installation manual also applies to Neo Green products (hereafter also referred to as “Modules”).

This manual provides important safety guidelines for the handling, installation, maintenance, and use of the Modules (hereinafter referred to as the “Installation and Instruction Manual”). **To ensure correct installation and stable power output, it is necessary to read, understand and strictly comply with all instructions contained in this Installation and Instruction Manual, before taking any steps involving the Modules.** As PV Modules are power generation products, professional technicians must perform the installation and adopt appropriate safety measures to avoid accidents. Please ensure you get familiar and comply with any and all requirements, laws, regulations and standards, including all health and safety regulations, applicable in the jurisdiction of installation of the Modules prior to engaging in any handling, installation, maintenance and/or use of the Modules.

The main and general norms and standards, with their class, that our modules comply with are:

- Class II (IEC61730:2023 and IEC61730:2016), for the protection class of the Module.
- Class A (IEC61730:2004), for the application class.
- Class C (in line with IEC61730-2 standard), for the fireproof rating. JKMxxxN-72HL4-BDX and JKMxxxN-66HL4M-BDX have a Class A fire rating.

1.1 Rules and regulations

The mechanical and electrical installation, as well as the handling, installation, use and maintenance of the Modules must comply with all local applicable laws, regulations and codes, including, without any limitation, electrical norms, construction codes and electrical connection requirements, as well as, mounting and/or other equipment instructions, environmental, health and safety, cultural heritage and landscape regulations, and ethical practices, as may be modified or amended from time to time, as well as any and all standards applicable to the relevant handling, installation, use and maintenance including but not limited to IEC62548, and any requirement of the relevant utility and grid operator. Regulations may differ based on site-specific conditions (such as building roof installation, vehicle applications, etc.) or on the installed system voltage (DC or AC). For specific terms, please contact your local authorities.

1.2 Disclaimer

JinkoSolar reserves the right to change the product specifications and this Installation and Instruction Manual without prior notice. We recommend checking our website regularly at

<https://jinkosolar.eu/> for the latest product and documentation information (here direct link to find latest Installation and Instruction Manual <https://jinkosolar.eu/downloads/pv-downloads/>).

JinkoSolar shall not be liable for any loss, damage or expense arising out of, or in connection with, the handling, installation, operation, use or maintenance of the Module, which is not compliant with this Installation and Instruction Manual.

JinkoSolar disclaims any liability for infringement of patents and third-party rights that may result from the use of the Modules. Customers are not authorized to use any patents or patent rights, nor any other intellectual property right, express or implied, by using JinkoSolar products.

The information provided in this Installation and Instruction Manual is based on JinkoSolar's current knowledge, as available of the date of release of this Installation and Instruction Manual, and experience which is believed to be reliable.

Jinko Solar reserves the right to issue recommendations, guidelines or instructions that may supplement or amend, from time to time as the case may be, the contents of this Installation and Instructions Manual. Any information, instruction, recommendation, guideline or product specifications do not constitute the terms of any warranty, express or implied.

The Modules shall be used strictly for the purpose they were manufactured for and intended for, any other use is not permitted, and in no event JinkoSolar shall be liable for any liability accrued therefrom or thereunder.

Should the Modules not be handled, installed, operated, used in accordance with this Installation and Instruction Manual: (a) the Modules will not benefit of the Limited Warranty; and (b) the relevant user shall hold harmless and indemnified JinkoSolar for any claim, defect, damage or liability whatsoever, arising out of, or in connection with such breach.

2. General information

There are two labels on the Module which contain the following information:

1. Nameplate (Figure 1): each Module has a nameplate, which indicates the Module type, the main electrical and safety specification parameters, etc.

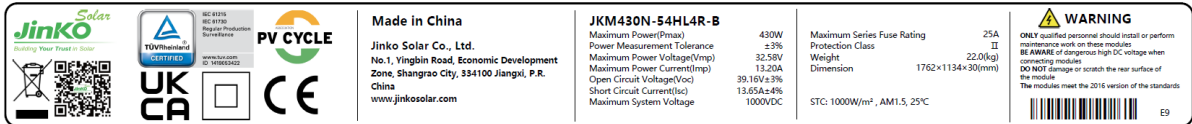

Figure 1. Nameplate example.

2. Serial Number and Bar Code Label¹ (Figure 2): each Module has a unique serial number and bar code as a unique identifier, which is laminated inside the Module permanently. This label can be normally found in the front side of the Modules in one of its corners, and in the middle of the rear side of the Module.



Figure 2. Latest Serial Number and Bar Code Label.

For additional information about the location of labels and other details regarding material layers and elements of PV modules, refer to Figure 3 and Table 1.

¹Jinko Serial Number consist of 24 digits. The production day is related to the warranty, and it can be extracted from digits 7-11, as explained in the corresponding warranty terms: <https://jinkosolar.eu/downloads/pv-downloads/>. If the module is previous to actual warranty, please check your contract or ask cs.eu@jinkosolar.com

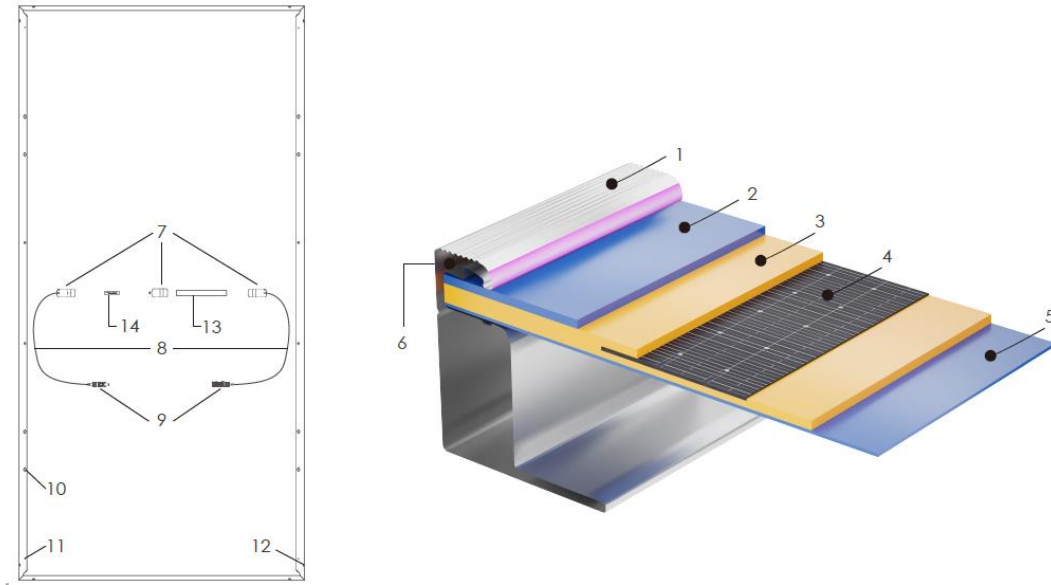

Figure 3. Location of labels, material layers and other Jinko Module elements.

1 Frame	2 Glass	3 EVA/POE	4 Solar Cell
5 Backsheet/Glass	6 Silica Gel	7 Junction Box	8 Cable
9 Connector	10 Mounting Hole	11 Grounding Hole	12 Drain Hole
13 Name Plate	14 Bar Code		

Table 1. Material layers and other Jinko Module elements.

Please refer to Figure 4 and Table 2 for main Module dimensions and distances between mounting holes. For specific values, check the relevant Module datasheet.

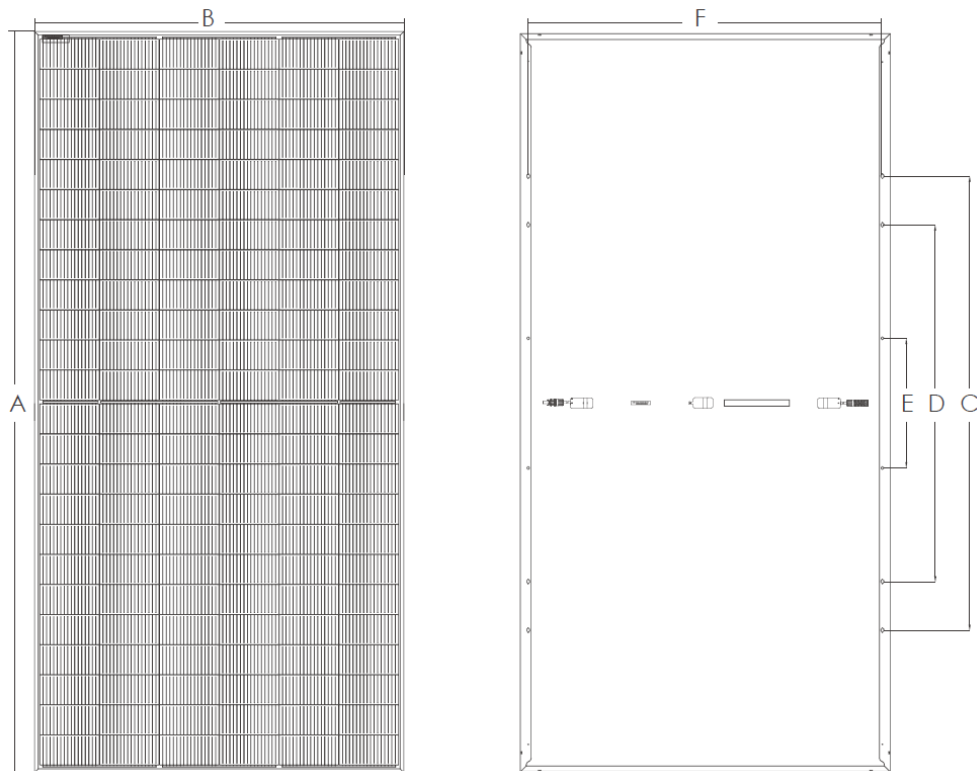

Figure 4. Main Jinko Modules dimensions and mounting hole distances.

A	Length
B	Width
C, D & E	Distances between mounting holes (just D and E in modules shorter than 2 m)
F	Distance between mounting holes, parallel to B

Table 2. Main Jinko Modules dimensions and mounting hole distances.

2.1 Regular safety

- a) *The Modules shall be used strictly for the purpose they were manufactured for and intended for, any other use is not permitted, hence do not use the Modules, for instance and without limitation to replace or partly replace roofs and walls of buildings. Follow your local regulations for building integration of photovoltaics.*
- b) *Handle Modules during deliveries and transport with care, avoiding any shocks that could damage the Modules, their assembly or /and cause cracks in the cell.*
- c) *Do not lift Modules using the attached cables or the junction box.*
- d) *Do not apply excessive force on the Module surface either directly, or indirectly by using objects or tools. Do not impact, and do not twist the Module frame to prevent cell damages and/or cell*

cracks.

- e) Do not alter, touch or modifying any part of the Modules unless explicitly authorized in writing by JinkoSolar. Refrain from removing, attempting to repair, or disassembling any component installed by JinkoSolar.
- f) Do not drill holes in the frame without authorization from JinkoSolar, as it may cause corrosion, damage or other negative effects.
- g) In no event Modules, junction boxes and connectors shall come into contact with unapproved chemicals: e.g., petrol, oil, acetone, alcohol, film strippers, potting compounds, TBP, cleaning agents, herbicides, rust inhibitors, descaling agents, etc. For more information and knowing which chemicals can be used in cleaning methods, please contact JinkoSolar technical support department at cs.eu@jinkosolar.com.
- h) Do not use junction boxes or connectors that are contaminated (with dust, corrosion, etc.), or broken Modules.
- i) Do not stand (see Figure 5) or step on the Module (see Figure 6) as there is a risk of damage to the modules and injury to the user.



Figure 5



Figure 6

- j) Pay attention to preventing sand, stones or other hard debris kicked up by operation and maintenance vehicles or lawn mowers during operation from striking the surface of the modules, causing glass or module damage.
- k) Use appropriate protective equipment when handling, installing, using and maintaining the Modules so to avoid direct contact with bare hands/skin, reduce the risk of electric shock, and protect hands from sharp edges. This includes standard and insulated safety tools and equipment (safety helmet, insulated gloves and rubber shoes, harness or belts, ladder, etc.). Please check the health and safety regulations applicable in your jurisdiction and strictly comply with them at all times in handling, installing, using and maintaining the Modules.
- l) When installing or maintaining the PV system, please do not wear metal rings, watches or other metal products, to avoid electric shock dangers or Module damage. Metal components could potentially come into contact with live parts of the module, such as connectors or other system areas that may be energized. This creates a risk of electric shock, particularly if a ground fault occurs in the installation, which could result in direct contact with a live part of the system.
- m) Do not use wet tools or wet PPE(s), and refrain from working under the rain, snow, windy or heavy mist conditions.

- n) Avoid direct open-air placement or stock of Modules before they are installed. If open-air storage is inevitable, always use additional rain protection for Modules. Ensure to add connector covers to all modules to prevent corrosion and the accumulation of dust inside the connectors, especially when they are stored for extended periods in humid, dusty, or corrosive environments.
- o) Junction boxes and female-male connectors interconnections of the Modules covered by this Installation and Instruction Manual meet IP68 (IEC60529) requirements. However, they must be protected from prolonged direct sunlight, water immersions and high humidity, to ensure long-term reliability. Keep connectors dry and clean, ensuring they are in good operating condition.
- p) Before connecting the male and female connectors, ensure that the contacts are free of corrosion, clean, and dry, and check the wiring status. When connecting, insert the male and female connectors until they engage, then gently pull to check if the engagement is secure. The correct/incorrect engagement visual diagram is shown in Figure 7 (for reference only; the actual connectors shall be based on the ones received on-site).



Figure 7 Schematic Diagram of Correct/Incorrect Engagement of Connectors

- q) Check the wiring condition: all wires shall not be detached from the Modules, and secure the wires with cable ties so that the wires do not scratch or squeeze the rear side of the Module. Please note the provisions of Section r) below and ensure to use protection caps in case you do not immediately interconnect connectors, especially in areas affected by high humidity, mist and in coastal areas.
- r) In order to avoid external matter such as sand or water vapour from entering and causing connection safety problems, once the Modules are taken out of the box and installed, the connectors between the Modules need to be connected immediately, and the connectors need to be kept dry and clean during the installation process. In areas with heavy dust, high salinity, or severe pollution, dust plugs (see Figure 8) must be installed on the connectors to prevent contamination before the connectors are mated. Prior to purchasing the modules, it is necessary to communicate with JinkoSolar about the project site conditions to ensure the provision of dust plugs. However, please note that the exposure time of dust plugs to the environment should not exceed one month.



Figure 8. Connector dust plugs.

2.2 Electrical performance safety

- a) *Modules generate DC electrical energy when exposed to sunlight or other light sources. Improper contact with active parts (elements that may be exposed to voltage), such as terminals, may result in burns, sparks, and lethal shock.*
- b) *Damage to, or opening of the front or rear glass of the Module, can create serious electrical hazards, including the risk of electric shock or fire. In case of a damaged Module, it must be promptly removed from the installation and replaced by a qualified technician and never intended to be repaired.*
- c) *Electrical specifications shown in datasheets are measured under Standard Test Conditions (STC), thus: Irradiance 1000W/m², module cell temperature 25°C, air mass = 1,5. The current and voltage generated by Modules in different environments are different from measured at STC. Therefore, when determining the specifications of the rated voltage, cable capacity, fuse capacity, controller capacity, and other output power related specifications, take the values of 1,25 times the short-circuit current and open-circuit voltage marked on the module. This multiplier serves as a reference and is commonly used; however, it is important to consult with your inverter/controller supplier for system configuration design, as local regulations may vary, impacting these considerations.*
- d) *Snow, water, or other reflective medium in surrounding environments that intensify light reflection will increase output current and power. Module voltage and power will increase under low temperature conditions.*
- e) *Artificially concentrated sunlight shall not be directed on the Module. Do not expose the back of the single glass Module to direct sunlight.*
- f) *To prevent arcs and electrical shocks, do not disconnect Modules under load without authorization and without the presence of qualified personnel; if disconnecting the connector is needed, turn off DC and AC inverters or cut off the main switch of the converter first.*
- g) *PV Module operation can only be stopped when they are kept from sunlight or covered by hard board (opaque material) or UV-proof materials.*
- h) *When connecting a battery storage system, strictly comply with the battery manufacturer's instructions for correct installation, operation, and maintenance to ensure system operation and user safety.*
- i) *Due to the risk of electrical shock, do not perform any work if the terminals of the Module are wet or exposed to high humidity.*
- j) *Do not operate on wet Modules. Should this be inevitable, please do so wearing fully dry PPE(s) and tools, at all times.*
- k) *Please follow the cleaning requirements in this Installation and Instruction Manual when cleaning Modules, refer to section 6.2.*
- l) *Only the Modules of the same size and the specifications within same range can be connected*

in series.

- m) The number of Modules that can be connected at a PV installation shall be determined by a qualified institution or person in accordance with the design specifications of the photovoltaic system and the local electrical design specifications.*
- n) Do not touch the Module, junction box or the connectors with bare hands or bare skin during installation or under sunlight, regardless if the Module is connected to or disconnected from the system. The glass surface and the frame may become hot, posing a risk of burns and electric shock.*
- o) Do not insert any metal object into the connector.*

2.3 Operation safety

- a) Read and follow the manual “Handling, Storage and Unpacking Instructions” to ensure proper management of the pallets: <https://jinkosolar.eu/downloads/pv-downloads/>. Any unpacking methods that deviate from the standard are prohibited.*
- b) Before unpacking, please check the product type, power bins, serial number, and relevant suggestions on the paper of the packaging box, as well any guidelines or instructions provide by JinkoSolar.*
- c) It is recommended to use art knife or cutter to remove the packing belt and wrapping film. Please handle gently the removal of the packing belt and wrapping film to prevent scratching or damaging the Modules in the box.*
- d) Ensure a proper environment before unpacking as well as enough man force (2 people minimum) to prevent the Module from slipping and hitting other modules, causing scratches, cracks, or deformation on the modules.*
- e) Once the Modules are removed from the pallet, they shall be promptly installed and connected to the inverter. If they are not installed immediately, protective measures (such as adding rubber joint cover, etc.) must be taken on the connectors' head to prevent water vapour, sand, dust, insects, or other contaminants from getting inside the connector and causing poor contact or corrosion of the connector. For further information please, refer to sections 2.1 and 2.2.*
- f) When inspecting PV Modules with AR coating technology, it will be normal to observe Modules with a slight colour difference at different angles.*
- g) Thermal expansion and contraction effects occur on the modules. During installation, the distance between two adjacent Modules must be $\geq 10\text{mm}$. If there are special requirements, please confirm such requirement in writing with JinkoSolar before commencing the installation.*
- h) During the installation, as for Module removal, maintenance, and any other related processes, it is recommended that the force applied between the cable and the connector, and the cable and the junction box, is not more than 60N.*

i) *Meaning of crossed – out wheeled dust bin:*

- *Do not dispose of electrical appliances as unsorted municipal waste, use separate collection facilities. Always comply with the relevant regulations applicable in your jurisdiction.*
- *Contact your local government for information regarding the collection systems available.*
- *If electrical appliances are disposed of in landfills or dumps, hazardous substances may leak into the groundwater and get into the food chain, damaging your health and well-being. Always comply with the relevant regulations applicable in your jurisdiction.*
- *When replacing old appliances with new ones, the retailer is legally obligated to take back your old appliance for disposals at least free of charge.*



2.4 Fire safety

- a) *Please use appropriate PV installation components, such as Modules, breakers, wires, etc, and strictly comply at all times with local laws and regulations, including but not limited to the building fire safety requirements before installation, such as fuses, circuit breakers and grounding connectors, etc.*
- b) *JinkoSolar Modules fire rating is set according to IEC61730-2 standard, and it can be found in the corresponding certificates: <https://jinkosolar.eu/downloads/pv-downloads/>. The Fire Class Rating of a Module for roof mounted system must meet local code requirements in order to achieve the specified System Fire Class Rating for a non-BIPV module. All PV systems have limitations of inclination required to maintain a specific System Fire Class Rating. Please get familiar with all such requirement prior to installation and strictly comply with them.*
- c) *For roof-top installations, it is responsibility of the designers or installers to ensure that the roof is suitable not only in terms of the structural load-bearing capacity, but also the fire resistance for the installation of the PV Modules in accordance to local laws and regulations.*
- d) *Make sure that the rear side of the Module and the mounting surface are fully ventilated. To facilitate ventilation and heat dissipation of the Module, the minimum distance between back side of the Modules and roof must be $\geq 10\text{cm}$, considering the normal physical phenomenon which the Modules will be concave to varying degrees due to the gravity. The minimum clearance of any Modules applied for special cases, please contact JinkoSolar's technical support department at cs.eu@jinkosolar.com.*
- e) *Different roof structures and installation modes will affect fireproof performance of buildings. Improper installation may lead to the risk of fire.*
- f) *Do not install the Modules anywhere close to open flames or flammable materials (hay, straw, wood, solvents, oils, etc.), or exposed to flammable and explosive gases.*

3. Installation conditions

3.1 Climate/Environment conditions and Site selection

The recommended weather conditions for installing Modules are:

- a) *Humidity: < 85% RH.*
- b) *Ambient air temperature range: -40°C to +40°C.*
- c) *Operating temperature: -40°C to +70°C.*

In most applications, for an optimal performance, JinkoSolar PV Modules should be installed in a location where they can receive maximum sunlight throughout the year. In the Northern Hemisphere, the Module should face south, and in the Southern Hemisphere, the Module should face north. Modules facing 30 degrees away from due South (or due North) will lose approximately 10% to 15% of their power output. If the module faces 60 degrees away from due South (or due North), the power loss will be 20% to 30%. Refer to the longitude and latitude of the location to determine the optimal azimuth of the Module.

The maximum altitude of Module installation is 2000m.

JinkoSolar standard PV Modules have passed the IEC 61701 salt spray corrosion test (method 6). In the case Modules are installed within 50m to 500m from the seashore, the connectors shall be protected, i.e. adding dust plugs. After removing the dust plugs, connect the connectors immediately and take other anti-rust measures to prevent rust. Offshore PV Modules are recommended if installation within 50 metres is required, please consult JinkoSolar for details prior to starting the installation.

Do not install the PV Module in a location where it would be immersed in water or continually exposed to water from a sprinkler or fountain, etc. When choosing a site, avoid trees, buildings or any other obstruction that could create shadows on the Modules at any time throughout the year. Shading causes loss of power output and may affect the optimum performance and safety issue of the PV Modules.

It is possible that Modules installed with restricted airflow are not allowed for use in some hot locations, depending on system design parameters. Installers should assess if the system design at a specific geographic location will result in a Module operating temperature greater than 70°C, and must consider and avoid these factors in design of systems.

3.2 Tilt angle selection

The tilt angle of the PV Module is measured between the surface of the PV Module and a horizontal surface (see Figure 9). The Module generates maximum output power when directly facing the sun.

JinkoSolar suggests the Module tilt angle to be maintained at more than 10° to allow the rain to wash away the dust, while the Module with too small tilt angle requires more frequent cleaning, which will affect the appearance and performance of the Modules.

For standalone systems, the tilt angle of the Modules should be selected to optimize the performance based on the season and sunlight. In general, if the Module output is adequate when the irradiance is low (e.g., winter), the angle chosen should be adequate during the rest of the year. For grid-connected systems, Modules should be tilted at the angle which will maximize the energy production from the Modules on an annual basis. Comply at all times with any law, regulation, standard or grid operator/utility requirements when installing the Modules.

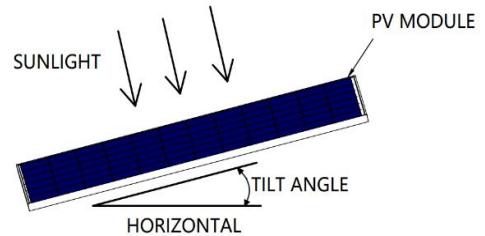

Figure 9 PV module tilt angle.

4. Mechanical Installation

Modules can be mounted by using the following methods: fixed installation-mounting with bolts, fixed installation-mounting with clamps and tracker installation.

Notes:

- a) All installation methods herein are only for reference, and they are based on the test results from third-party tests and JinkoSolar internal tests. While we extensively test various mounting scenarios, the vast diversity in materials and designs globally, including special profiles, makes it impossible to guarantee exact load specifications for installations with unique materials or designs. Special designs should be tested by the mounting companies, to ensure the reliability of the systems.
- b) JinkoSolar will not provide related mounting accessories.
- c) The system installer or trained professional personnel must be responsible for the PV system's design, installation, and mechanical load calculation and system security. JinkoSolar shall not have any responsibility in the PV system's design, installation and mechanical load calculation and system security. The design must take into consideration Module's bent/torsion, frame dimensions, fixation holes location and any other mechanic characteristic.
- d) Before installation, the following items shall be addressed:
 - Visually check the Module for any damage. Clean the Module if any dirt or residue remains.
 - Check if Module serial number stickers match.

- e) *The maximum loads that different types of Modules can withstand on the front side and back side are dependent on installation methods, which can be referred to Table 4, Table 7 to Table 9 and Table 10. If there is heavy snow and strong wind on the Module installation site, take special protection to meet the actual requirements.*
- f) *All load values provided in this Installation and Instruction Manual are maximum test load values, measured in Pa and describe as follows:*

$$\text{Maximum Test Load} = 1.5 \text{ (Safety factor)} \times \text{Design Load}$$

- g) *The Module must be mounted on the bracket according to the following installation methods shown in section 4 of this document. If you intend to install JinkoSolar modules using a different method from those outlined in this document, please consult JinkoSolar for evaluation and approval beforehand. Failure to do so will void the warranty.*
- h) *Under the mounting method of the fixed bracket as specified in this Installation and Instruction Manual, the Modules will be concave to varying degrees due to the gravity, which is a normal physical phenomenon and does not affect the normal use and performance of the Modules. Any other external forces will cause additional sinking of the Modules, so any operation of the Modules should comply with this Installation and Instruction Manual.*

4.1 Fixed installation-mounting with bolts

Install the Module on the rack using anti-corrosion bolts, elastic washers and flat washers with sufficient torque to allow the Module to be properly secured. See Figure 10 a) and b) for detailed installation information.

Table 3 lists different sizes of bolts for different mounting holes, along with torque recommendations. However, it is crucial to consult the installer or bracket supplier to obtain the exact torque value for your specific installation.

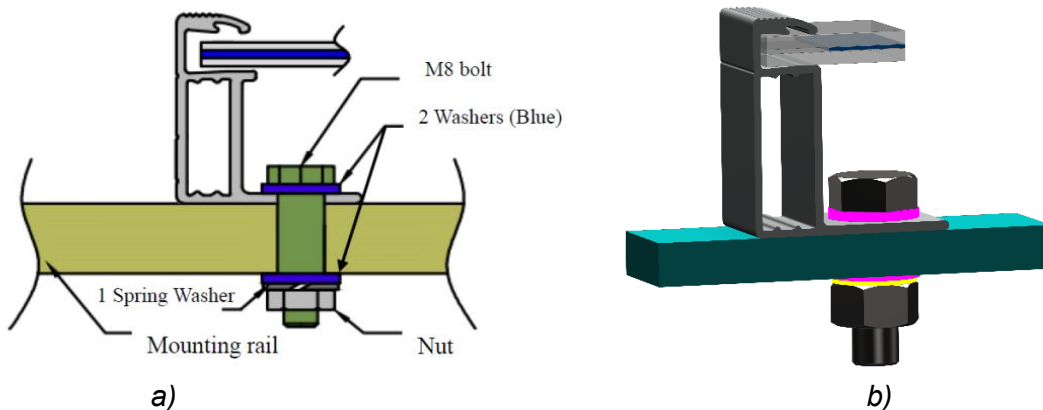

Figure 10 Mounting with bolts (a) schematic (b) 3D design of the installation with bolts.

Mounting hole (mm)	Bolt size	Reference torque (Nm)
14 x 9	M8	16-20
10 x 7	M6	9-12

Table 3. Bolts for different mounting holes.

Bolting installation		
Module type (JKMxxx...)/Glass thickness	Four inner mounting holes (Maximum Test Load Pa)	Four outer mounting holes (Maximum Test Load Pa)
N-48HL4M-DV (2.0 mm) N-48HL4M-DB (2.0 mm) N-48HL4M-BDV (2.0 mm) N-54HL4R-(V) N-54HL4R-B N-54HL4R-BDB N-72HL4-BDX	+6000/-4000	/
N-48HL4M-DV (1.6 mm) N-48HL4M-DB (1.6 mm) N-54HL4M-BDV N-60HL4-(V) N-72HL4-(V) N-72HL4-BDV N-78HL4-BDV	+5400/-2400	/
N-66HL4M-BDV N-66HL4M-(V) N-66HL5-BDV	/	+5400/-2400
N-66HL4M-BDX	/	+6000/-4000

Table 4 Test loads for inner and outer four-hole mounting for different modules.

Note that the above pictures show mounting rails parallel to the short side of the Module. If special mounting system or special installation method is required, please verify the torque and material compatibility with the supplier of the racking system.

4.2 Fixed installation-mounting with clamps

The clamps must not be installed in contact with the front glass of the Module and must not deform, or exercise excessive pressure on, the Module frame. Recommended clamp schematic shown as follows (see Figure 11). Ensure that the clamps do not create a shadow on the Module. Under no circumstances may the frame be altered. When choosing the mounting method for the clamps, make sure that there are at least four clamps on each Module. Different mounting positions of the clamps, as well as the way rails support the modules, determine the maximum load capacity of the Module. Table 7 to Table 9 as follows, show the different mounting methods and the positions of the clamps and rails for the different mounting methods. The distance between the installation position of the long-side clamp and the edge is represented by L in Table 7 to Table 9. The distance between the installation position of the short-side clamp and the edge is represented by S in Table 8 and Table 9.

Depending on the local wind and snow loads, if there is a possibility of excessive load combinations:

- Additional clamps could be required to ensure that the Module has enough load carrying capacity. Clamp dimensions, contact area and torque must follow minimum values shown in Table 5.
- Longer and/or stronger profiles/rails could be required to ensure that the Module has enough load carrying capacity.
- Modules with a length greater than 2.2 m and a width greater than 1.3 m are recommended to be mounted with the camber clamps shown in Figure 11 - d), which enables the clamps to fit better with the frame and provide more stable performance under extreme environmental conditions.

The torque value applied during installation of the clamps should be high enough to securely hold the Module. Please always consult the installer or bracket supplier for exact torque value.

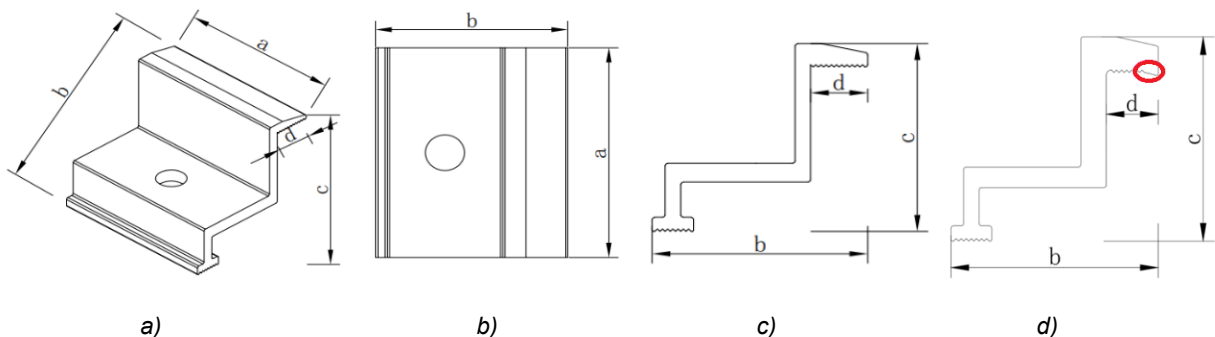

Figure 11. Recommended clamp schematic.

Length of the clamp (a)	≥50 mm ≥60 mm (for modules greater than 2.2x1.3 m)
Thickness	≥3 mm
Overlap of the frame of the module (d)	10-11 mm
Torque	16-20 Nm (M8 bolt)

Table 5. Minimum values for clamp dimensions, contact area and torque.

The minimum dimensions of clamps specified in this Installation and Instruction Manual have been tested and verified through the installation process and serve as a baseline for proper installation. However, it is important to note that these minimum values may not guarantee compatibility with all variations of clamps that may exist in the market. Using clamps with dimensions lower than the recommended minimums may result in insufficient clamping force and compromise the integrity of the installation.

It is important to ensure that any alternative clamps used in the installation meet the necessary performance standards and do not compromise the safety and integrity of the system.

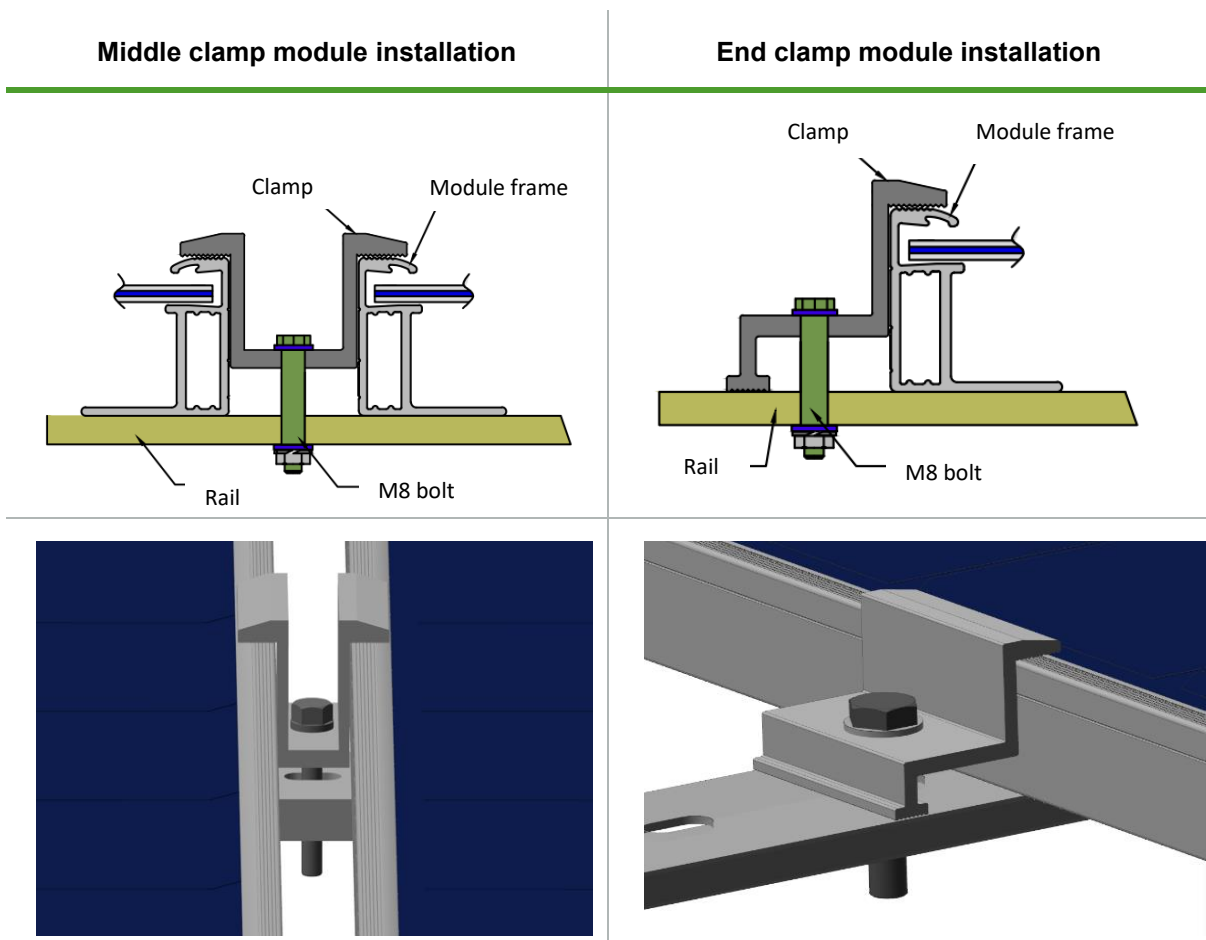

Table 6. PV module installed at the side with Clamp mounting.

Please thoroughly review the maximum test load specified for each module type, contingent on the chosen installation method.

Long side clamping (with rails)							
Method A Long side clamping (4pcs), rails (2pcs) parallel to short side.	Method B Long side clamping (4pcs), rails (2pcs) parallel to long side.			Method C Long side clamping (6pcs), rails (3pcs) parallel to short side.			
Mounting method / Range	Method A			Method B		Method C	
	L= A/4±50	L= A/5~A/4	L= A/5±50	L= A/4±50	L= A/5±50	L1=400	L1=450
Module Type(JKMxxx...)/Height/Glass thickness	Maximum test load (Pa)						
	N-54HL4-(V) N-54HL4R-(V) N-54HL4R-B	/	/	+6000 /-4000	/	+2400 /-2400	+6200 /-4200
N-54HL4R-BDB	/	+6000 /-4000	/	/	+3600 /-2400	+6200 /-4200	/
N-48HL4M-DV (2.0 mm) N-48HL4M-DB (2.0 mm) N-48HL4M-BDV (2.0 mm)	/	+6000 /-4000	/	/	+3600 /-2400	/	/
N-48HL4M-DV (1.6 mm) N-48HL4M-DB (1.6 mm)	/	+5400 /-2400	/	/	/	/	/
N-54HL4M-BDV	/	/	+5400 /-2400	/	+3200 /-2400	/	+5800 /-3000
N-60HL4-(V)	/	/	+5400 /-2400	/	+2400 /-2400	+5800 /-3200	/
N-66HL4M-BDV	/	+5400 /-2400	/	+3000 /-2400	/	/	+5800 /-3000
N-66HL4M-V	/	+5400 /-2400	/	+2000 /-2000	/	/	+5400 /-3000
N-66HL4M-BDX	+6000 /-4000	/	/	+3600 /-3000	/	/	+6400 /-4000
N-66HL5-BDV	+5400 /-2400	/	/	/	/	/	/
N-72HL4-BDX	+6000 /-4000	/	/	+3200 /-3000	/	/	+6400 /-4200
N-72HL4-(V) (B30)	/	+5400 /-2400	/	+2000 /-2000	/	/	+5800 /-2400
N-72HL4-(V) (B35)	/	/	+5400 /-2400	+2000 /-2000	/	/	+5800 /-3000
N-72HL4-BDV	+5400 /-2400	/	/	+3000 /-2400	/	/	+5400 /-3000
N-78HL4-BDV	+5400 /-2400	/	/	+2800 /-2400	/	/	+5400 /-2800

Table 7. Maximum test load values for different modules with long side clamps mounted with rail.

Short-& long side clamping, and short-side clamping (with rails)

Mounting method /Range		Method D		Method E		Method F	
		S=130-240	S=100-240	S=130-240	S=100-240	S=100~240 L=A/5±50mm	
Module Type (JKMxxx...) /Height/Glass thickness		Maximum test load (Pa)					
N-48HL4M-DV (2.0 mm) N-48HL4M-DB (2.0 mm) N-48HL4M-BDV (2.0 mm) N-54HL4R-(V) N-54HL4-(V) N-54HL4R-B N-54HL4R-BDB N-54HL4M-BDV N-60HL4-(V)		/	+2000/-1600	/	+1600/-1600	+2400/-2400	
N-66HL4M-BDV		+1600/-1000	/	+800/-800	/	/	
N-72HL4-(V) (B30)		+1600/-1000	/	+800/-800	/	/	
N-72HL4-BDV		+1600/-1200	/	+1000/-1200	/	/	
N-78HL4-BDV		+1600/-800	/	+800/-800	/	/	

Table 8. Maximum test load values for different modules with short/long clamps mounted with rails.

Railless clamping					
Method G Long side clamping (4pcs)		Method H Long side clamping (6pcs)		Method I ³ Short side clamping (4pcs)	
					
Mounting method /Range	Method G			Method H	Method I
	$L=A/4\pm 50$	$L=A/5\sim A/4$	$L=A/5\pm 50$	$L1=A/4\pm 50$ $L2=(A/2-L1)\pm 50$	$S=0-100$
Module Type (JKMxxx...) /Height/Glass thickness	Maximum test load (Pa)				
N-54HL4R-(V) ² N-54HL4R-B ²	/	/	+3200 /-2400	+3200/-2400	+1600/-1600
N-48HL4M-DV (2.0 mm) N-48HL4M-DB (2.0 mm) N-48HL4M-BDV (2.0 mm) N-54HL4R-BDB	/	/	+3600 /-2400	+3600/-2400	+1600/-1600/
N-54HL4-(V) ²	/	/	+4200 /-2400	+4800/-2400	+1600/-1600
N-54HL4M-BDV	/	/	+3200 /-2400	+3200/-2400	+1600/-1600
N-60HL4-(V)	/	/	+3200 /-2400	+3200/-2400	+1600/-1600
N-66HL4M-BDV	+3000 /-2400	/	/	+3600/-2400	+800/-800
N-72HL4-(V) (B35)	/	+2400 /-2400	/	+2400/-2400	+800/-800
N-72HL4-BDV	+3000 /-2400	/	/	+3600/-2400	+1000/-1000
N-78HL4-BDV	+2800 /-2400	/	/	+3400/-2400	+800/-800

Table 9. Maximum test load values for different modules with clamps mounted without rails.

²For method I, when using **non-slip clamps**, equal or longer than 80 mm, maximum test loads will be **+2400/ -1800 Pa**.

³Method I is also called "corner method". Here clamps can always be placed between 0-100 mm from module corner, in both short and long sides.

4.3 Tracker Installation

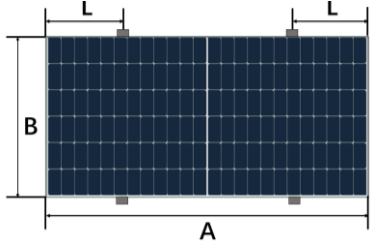
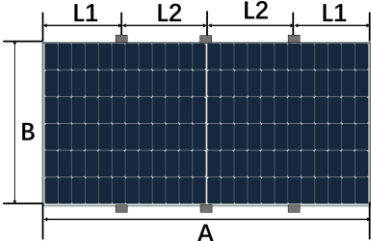
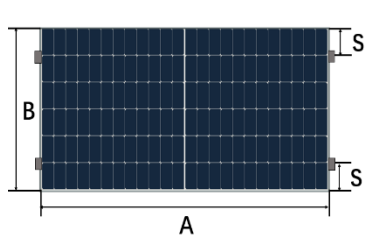
JinkoSolar Modules also have high compatibility with various mainstream tracker systems in the industry. The maximum test load that JinkoSolar Module can achieve is as listed in Table 10 below.

Module type (JKMxxx...)	Tracker system	Installation	Test load (Pa)
N-54HL4-(B)-(V)	ATI V3	Through bolt clamp 1300/1400 mm	+4100/-3200
N-78HL4-(V)	NEXTracker 1P	NT Standard Rail (400) Mounting hole: 400 mm	±1800
N-72HL4-BDV	NEXTracker 1P	NT Standard Rail (400) Mounting hole: 400 mm	±2400
	PVH AXONE DUO-INFINITY	Short rail: 91x428x1 Mounting hole: 400 mm	±1800
	ATI V3	Through bolt clamp 1300 mm bolting at 1100 mm position only	±2400
		Through bolt clamp 1400 mm bolting at 400 mm and 1400 mm positions	±3300
N-78HL4-BDV	NEXTracker 1P	NT Standard Rail (400) Mounting hole: 400 mm	±1800
	PVH AXONE DUO-INFINITY	Short rail: 91x428x1 Mounting hole: 400 mm	±1600
		Long rail: 29x1228x1.5 Mounting hole: 400 mm and 1200 mm	+2100/-2300
N-66HL4M-BDV	NEXTracker 1P	NT Standard Rail (400) Hole spacing: 1096 mm Mounting hole: 400 mm	+1800/-1800
	ATI V3	NT Standard Rail (400) Hole spacing: 1096 mm Mounting hole: 400 mm	+1800/-1800
N-66HL5-BDV	NEXTracker 1P	NT Standard Rail (400) Mounting hole: 400 mm	+2100/-2100
		NT Standard Rail (790) Mounting hole: 790 mm	+2600/-2400
	PVH AXONE DUO-INFINITY	Short rail: 91x428x1 Mounting hole: 400 mm	+1300/-1250

Table 10. Tracker installation methods and related maximum test loads.

Avoid installing PV Modules above torque tube connector, post heads or any other part of tracker higher than the torque tube if there is not a certain horizontal distance (recommend 300mm - 500mm) between edge of the module and any of those tracker parts. The aim of this distance range is to

prevent interference between the tracker structure and the Module junction box during tracker rotation, which may cause damage to the junction box and affect Module performance.

For detailed installation drawings and installation method, please refer to installation manual of tracker supplier. For other tracker systems that are not listed in Table 10, please contact Jinko for more information (cs.eu@jinkosolar.com).

5. Electrical Installation

5.1 Electrical property

For the electrical design, please find the main electrical parameters shown in the datasheet and product label.

Modules must be installed and connected with the foam tube removed first. JinkoSolar does not guarantee the safety of the product or the consistency of the technical parameters if the connectors and tools used are not officially designated or authorized by JinkoSolar, or the Modules or connectors are not installed according to specifications and strictly in compliance with this Installation and Instruction Manual, as well as with any applicable law, regulation, standard, requirement, including without limitations, those of the grid operator or relevant utility.

Modules can be connected both in series or in parallel, reasonable design is required according to the system configuration. In any case, string size (quantity of Modules that can be connected together, in series/parallel) must be calculated taking into consideration local regulations, chosen inverter and project location (environmental conditions, which may vary from STC). This must be done by qualified professionals at all times.

When Modules are in series, the string voltage is the sum of each Module individual voltage. Modules with different electrical parameters must not be connected in series. String voltage must not be higher than the maximum permitted system voltage, as well as inverter's maximum input voltage and other electrical devices that may be installed in the system. To assure this, we recommend calculating the open circuit voltage of the array at the lowest expected ambient temperature of the project location, by using the following formula:

$$\text{Max. system voltage} \geq N \cdot V_{oc} \cdot [1 + TC_{VOC} \cdot (T_{min} - 25)]$$

Where:

- N = Number of Modules in series.
- V_{oc} = Open circuit voltage (refer to product label or datasheet).
- TC_{voc} = Temperature coefficient of open circuit voltage (refer to product label or datasheet).
- T_{min} = Minimum ambient temperature.

When Modules are connected in parallel, the string current is the sum of each Module individual current. In this case, the maximum recommended number of parallel connections is:

$$N \leq \frac{\text{Fuse Rating}}{I_{sc}} + 1$$

Where:

- N = Number of maximum parallel connections.
- Fuse Rating = Maximum fuse rating value in an array string (refer to product label or datasheet).
- I_{sc} = Short circuit current (refer to product label or datasheet)

PV Modules connected in series shall have similar current, (please contact JinkoSolar if there is any concern), and Modules must not be connected together to create a voltage higher than the permitted system voltage stated in the label of the module. The maximum number of Modules in series depends on system design and the rating of the inverter used.

The maximum current rating of the Module array is identified on the product nameplate or in the product specification, and the current rating also relates to the maximum reverse current that can be applied to a single module. For example, when a Module is shaded, other Modules connected to it will form a load causing a current loop. Depending on the maximum fuse current rating of the Modules and the local electrical installation standards, the connection of parallel strings of Modules needs to be fitted with suitable fuse protection for circuit protection reasons.

Open the combiner box of the control system and connect the conductor from the PV arrays to the combiner box in accordance with the design and local codes and standards. The cross-sectional area and cable connector capacity must satisfy the maximum short-circuit of the PV system (for a single module, it is recommended that the cross-sectional area of cables be 4mm² and certified to IEC 62930 type 131), otherwise cables and connectors will become overheating for large current. Please pay attention that the temperature limit of cables is 90°C.

Jinko Modules junction boxes contain factory-installed bypass diodes. These diodes are connected in parallel with each cell string to allow the current flow to the next cell array in case there are hot spots or partial shadows in any of the other cells' string. This will avoid performance and heating losses.

- If Modules are incorrectly connected to each other, the bypass diodes, cables or junction boxes may be damaged.
- Keep in mind that bypass diode is not an over-current protection.
- Please do not try to open module junction boxes by yourself.
- Connectors and bypass diodes from different manufacturers should not be mated together. If such a replacement is needed, please contact JinkoSolar.

For floating applications where modules will be installed on floating structures, please contact JinkoSolar's technical support department at cs.eu@jinkosolar.com.

5.2 Wiring and cables

The wiring and cable management should be designed, reviewed and approved by the EPC contractor, especially for assemblies using tracking brackets. The required cable lengths should be checked in advance, to ensure good functionality and proper installation.

The wiring should be checked for correctness before starting the system. If the measured open-circuit voltage (V_{oc}) and short-circuit current (I_{sc}) do not match the specifications provided, there may be a wiring fault.

Each string should be left open-circuit until the system is connected to the grid after the Modules have been installed. Appropriate protection is required to avoid the ingress of water vapour and dust.

JinkoSolar recommends the following wiring methods (see Table 11).

<p>Vertical mounting: Select standard cables</p>	 <p><i>Dual-row module wiring schematic</i></p>	 <p><i>Single-row module wiring schematic</i></p>
<p>Vertical mounting: Custom length cables</p>	 <p><i>Leapfrog wiring</i></p>	
<p>Horizontal mounting: Custom length cables</p>	 <p><i>Module wiring schematic</i></p>	

Table 11. Module wiring schematic.

(Note: the exact number of series connections will be determined according to the actual design)

When wiring modules, always keep in mind the minimum bend radius (see Figure 12). This minimum bend radius is the permissible curvature the cable can be bent around. Depending on the type of cable, a specific coefficient (Cable multiplier), must be applied. For our DC cables this parameter is 4.

$$\text{Minimum Bend Radius (R)} = \text{Cable Outer Diameter (d)} \cdot \text{Cable Multiplier}$$

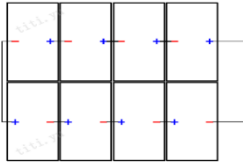
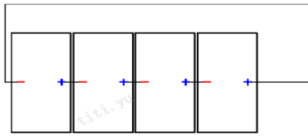
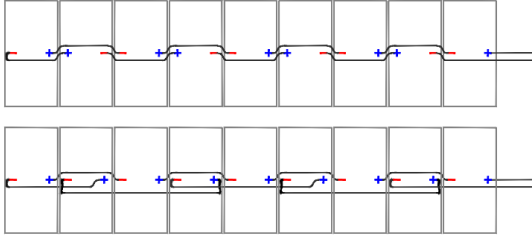
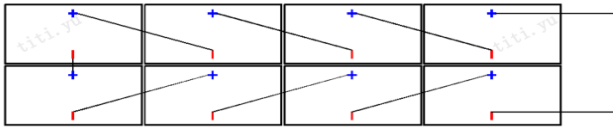
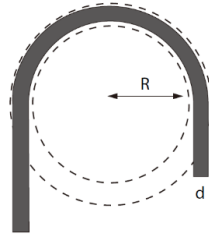

Figure 12. Minimum Bend Radius.

Jinko does not guarantee the safety of products and technical parameters consistency if the connecting heads and tools used are not officially specified or authorized by Jinko or are not installed according to the official guidance of the Installation and Instruction Manual and local regulations.

Before the commissioning and operation of the power station, verify the electrical connection of modules and strings, ensuring all connections and polarities are correct, and the open circuit voltage meets the requirements of the acceptance criteria. Incorrect connections may lead to electric arc and electric shock. Please always check that all electric connections are reliable and that all connectors are fully locked.

Open the combiner box of the control system and connect the conductor from the PV arrays to the combiner box in accordance with the design and local codes and standards.

Three split junction boxes (see in Figure 13) with IP68 installed in Jinko modules provide the necessary safety protection for cable and wiring connections, including contact protection of non-insulating electric parts.

The length of each junction box is given at the component specifications.

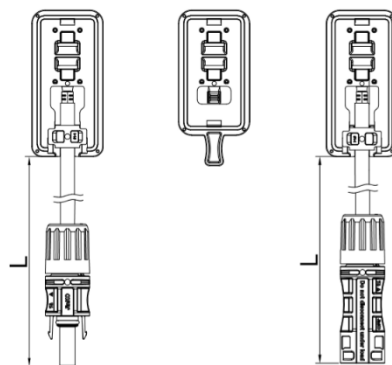

Figure 13. The half-cut cell module/split junction box.

For more details about connectors, please refer to their manual: <https://jinkosolar.eu/downloads/pv-downloads/>.

5.3 Grounding

For safety reasons and to protect modules from lightning and electrostatic damage, the Module frame must be grounded. The grounding design and the materials used should be in accordance with local national, regional or international regulations, codes, laws and standards, and the grounding connection should be carried out by qualified electricians at all times.

The grounding device must penetrate the anodic oxide film of the component frame and make full contact with the interior of the aluminium alloy, and the grounding conductor must be connected to earth ground through a suitable grounding electrode.

There are grounding holes with a diameter of 4mm on the long side of the back frame of the module, by the edge part. The grounding hole on the frame is marked with typical grounding symbol (\perp) according to IEC 61730-1 standard. These holes can only be used for grounding with bolts, so cannot be used for Module installation. This method includes bolt, flat washer, star washer, washer and nut (see Figure 14). The bolts should be tightened when grounding is installed. The frame of the Module must not be punched with additional holes and no damage should be done to the module frame or the grounding wire.

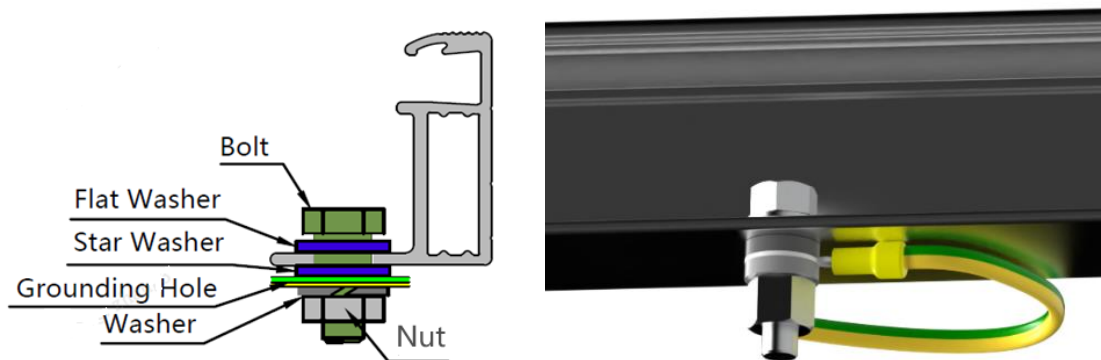

Figure 14. Grounding hole with bolts.

Grounding devices and materials must be provided by qualified manufacturers. Bolts, nuts and washers shall be of a size to match the grounding hole and made of stainless steel, and grounding wires shall be made of copper core wires with a size of AWG 6-12 (4-14 mm²) and 90°C, and shall be in accordance with relevant local national, regional or international regulations, laws and standards.

JinkoSolar allows other grounding methods. However, the following requirements need to be met:

- a) It is the sole responsibility of the Installer to select the correct grounding system in accordance with the applicable local laws, regulations, standards including but not limited to grid operator or utility requirements.
- b) Said grounding system must comply with the corresponding electrical codes.

- c) *JinkoSolar Modules must be properly grounded in accordance with the applicable local laws, regulations, standards including but not limited to grid operator or utility requirements.*
- d) *The selected grounding methodology does not impact the JinkoSolar Power or Product Warranty in any way.*
- e) *JinkoSolar is neither liable nor responsible for any failure or defect caused by the selected grounding methodology.*

6. Maintenance and care

It is required to perform regular inspection and maintenance of the Modules, especially during the warranty period. To ensure optimum Module performance, JinkoSolar recommends the following maintenance measures:

6.1 Visual inspection

A visual inspection should be conducted upon receiving the pallets (before unloading them from the truck) and after opening the package, as well as immediately before installation, to ensure that all modules are in perfect condition.

Inspect the Modules visually to find if there are any visual defects, if there are, the following items should be evaluated:

- a) *If the Modules are observed having slight module colour differences at different angles, this is a normal phenomenon for modules with anti-reflection coating technology. If the colours are within the cell, please consult JinkoSolar for further analysis.*
- b) *Whether the glass is broken.*
- c) *No sharp objects are in contact with the PV Module surfaces.*
- d) *The PV Modules are not shaded by unwanted obstacles or foreign material.*
- e) *Corrosion along the cells' busbar. The corrosion is caused by moisture intrusion through the module rear side of the module. Check the rear side of the module for damage.*
- f) *Check whether the back sheet is burnt.*
- g) *Check if screws and mounting accessories are tight, adjust and tighten as necessary.*

6.2 Cleaning

- a) *A buildup of dust or dirt on the Module front face will result in a decreased energy output. Clean the Module preferably once per month, more frequently in dusty conditions, using soft cloth dry or damp. Water with high mineral content may leave deposits on the glass surface and is not recommended. It is recommended to use neutral water of the PH value ranging from 6.5 to 8 to clean the glass, so as not to cause damage to the glass coating layer.*
- b) *Never use abrasive material under any circumstances.*
- c) *In order to reduce the potential for electrical and thermal shock, JinkoSolar recommends to clean PV Modules during early morning or late afternoon hours when solar irradiation is low and the Modules are cooler, especially in regions with high temperatures.*
- d) *Never attempt to clean PV module with broken glass or other signs of exposed wiring, as this presents a shock hazard.*
- e) *No recommend to priority use chemicals when cleaning Modules as this may affect the module warranty and energy yield. For the environment with extreme climate, please contact JinkoSolar after-sales department for specific requirement if needed.*
- f) *For single-side Module, backsheet cleaning is not necessary; for dual-glass Module, cleaning the Module backside regularly when necessary, and follow the requirements in 6.1 a) – e). Please wear insulated gloves and pay special attention to the cables and electrical connections during the backside cleaning.*
- g) *If a water gun is used to flush the modules, be careful of the water pressure to avoid damaging the Modules.*
- h) *If using a hose or backpack style pressure set we recommend the pressure of the water should be less than 675kPa.*

6.3 Inspection of Connectors and cables

It is recommended to implement the following preventive maintenance every 6 (six) months:

- a) *Check the sealing gels of the junction box for any damage.*
- b) *Examine the Modules for signs of deterioration. Check all wiring for possible rodent damage, weathering and that all connections are tight and corrosion free. Check the electrical grounding.*

For more details, please refer to O&M manual: <https://jinkosolar.eu/downloads/pv-downloads/>.



Installation Manual, Datasheets and Others

Track record

Version	Date	Change
01	2024.09.04	All
02	2024.12.17	<p>Front page image.</p> <p>Section 4.2: update of mechanical loads.</p> <p>Section 4.3: update of tracker systems.</p> <p>Section 6.3: update of the description.</p>
03	2025.01.15	<p>Section 1.</p> <p>Section 2.</p> <p>Section 3.</p> <p>Section 4.</p> <p>Section 4.2: update of mechanical loads.</p> <p>Section 5.</p>
04	2025.02.27	<p>Section 2.1</p> <p>Section 4.</p>
05	2025.03.14	<p>Section 1.</p> <p>Section 2.1.</p> <p>Sections 4.1 and 4.2.</p>
06	2025.03.25	<p>Abbreviations</p> <p>Section 4.2.</p>
07	2025.06.10	<p>Section 4.1.</p> <p>Section 4.2.</p> <p>Section 4.3.</p> <p>Section 5.1.</p>

JinkoSolar

Technical Customer Service Europe: cs.eu@jinkosolar.com

Technic Support: technicEU@jinkosolar.com

Pre Sales: Globalpresales@Jinkosolar.com

After Sales: cs@jinkosolar.com

www.jinkosolar.eu

www.jinkosolar.com